

Article number: 439600160

Description: Rota-fix shaft-hub connection FS160x210

Note: Self centering - very high torque.

## Measures

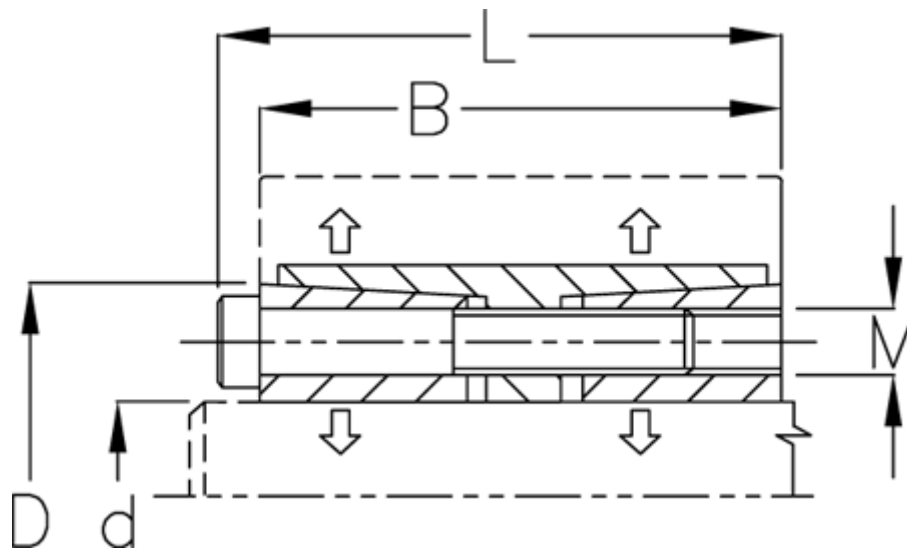

B mm	= 82
d H8 mm	= 160
D mm	= 210
Fit tolerance	= Aksel h8, Nav H8
F kN torque	= 623.0
L mm	= 94
M mm	= M12
P N/mm <sup>2</sup> surface pressure on shaft/hub	= 145

Surface roughness	= R? ? 3.2 $\mu$ m
T N m torque	= 49800
Ts N m bolt tightening torque	= 145.0